

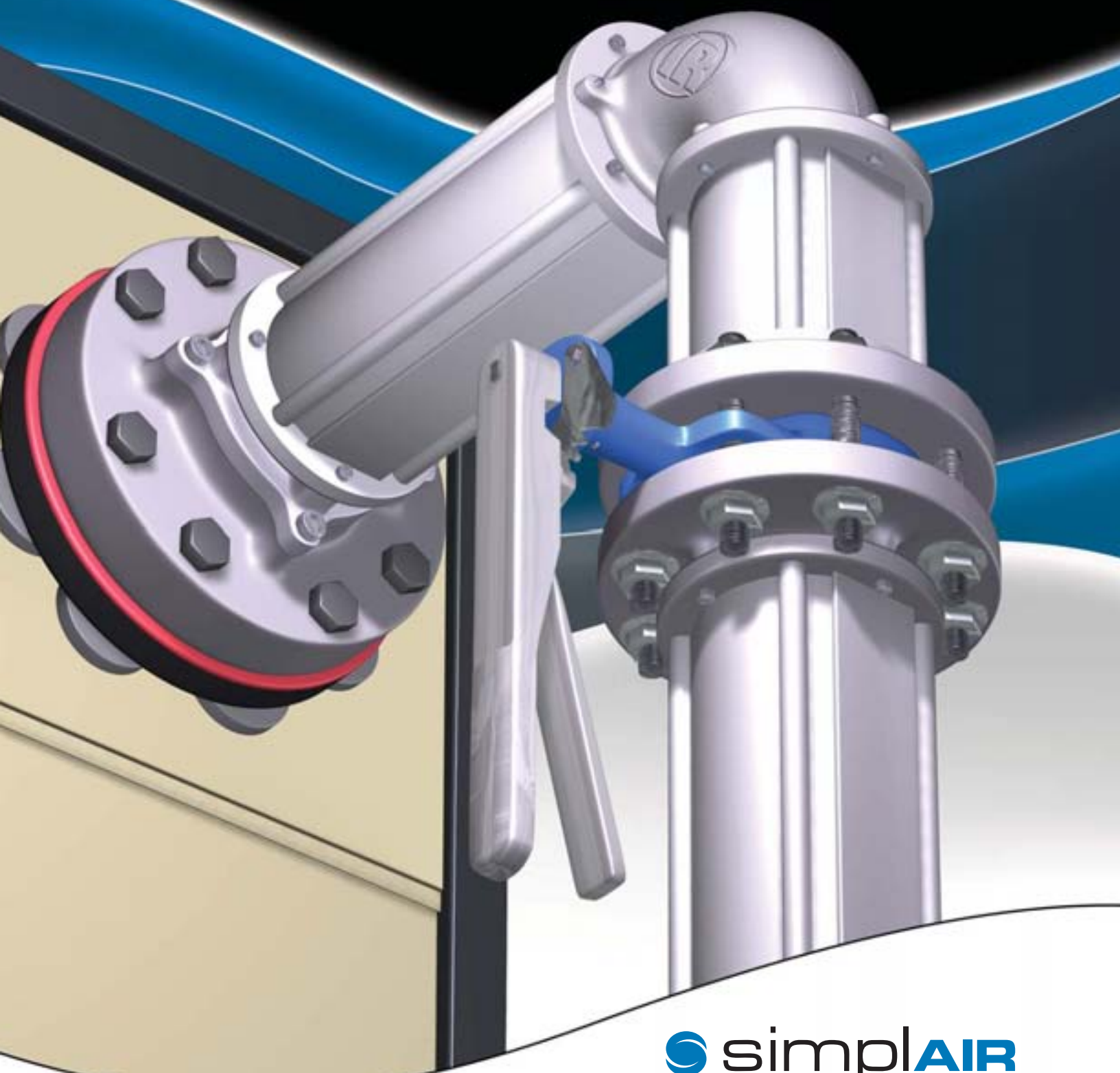

Global Services



 **simplAIR**  
evolution

**Compressed Air Piping System**

## Table of Contents

Simplair Features and Benefits .....	4
Compressed Air Piping System .....	5
Piping System Accessories and Tools .....	8
Flow Rates Through Tubing .....	12
Piping and Distribution Accessories .....	14
Ball Valves .....	18
System Pressure Controllers .....	19



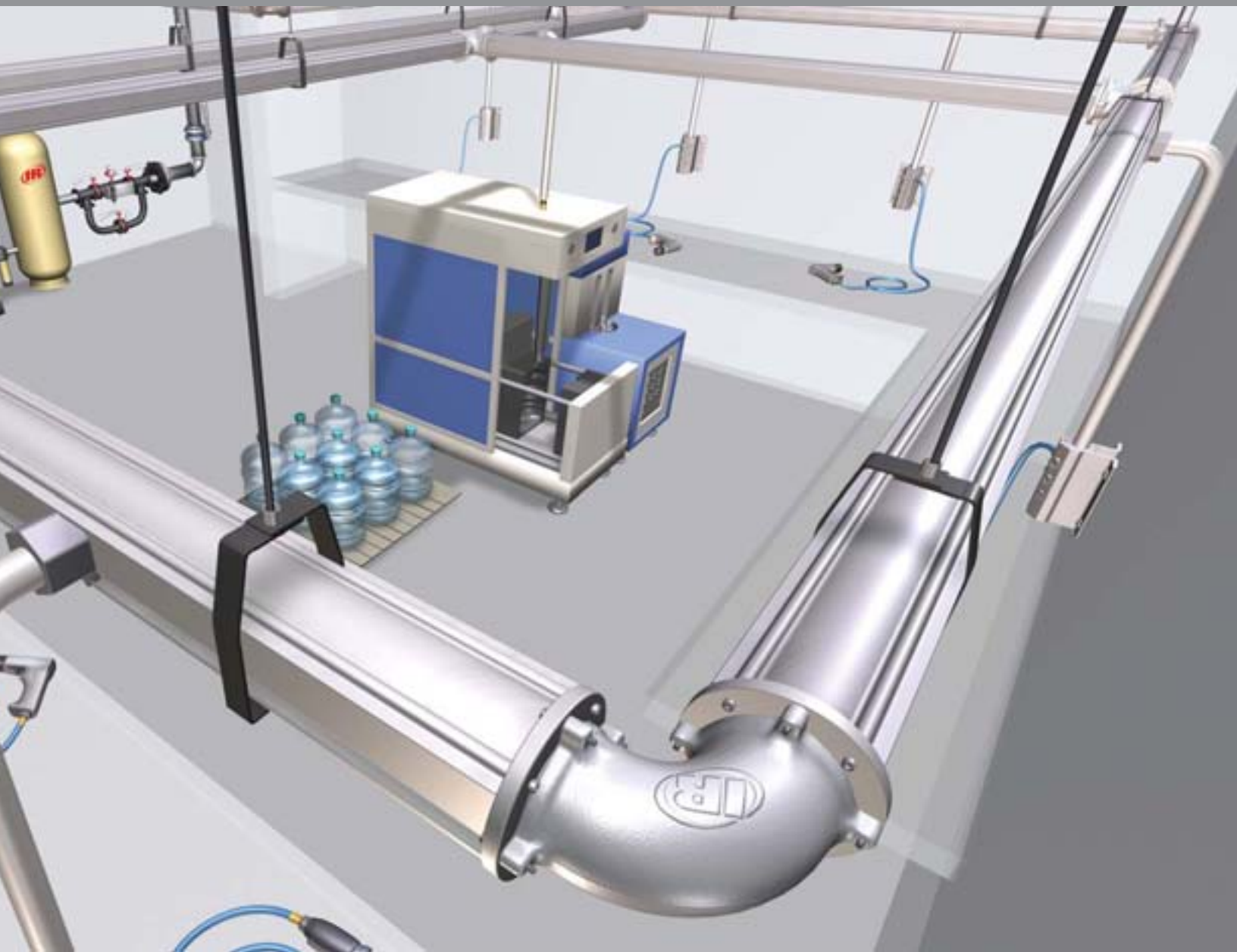

**Simplair Evolution – Simplicity, Versatility,  
and Performance in one integrated piping system.**

- Easy to install
- Flow rates up to 8,000 cfm
- Lightweight
- Leak-free
- High structural strength
- Low pressure drop
- Simple connections

## Features and Benefits



### Introducing A New Evolution In Piping ...

**Simplair Evolution. Simplicity, Versatility, Performance In One Integrated System**

In the past, compressed air users have been burdened by the limitations of traditional piping systems – difficult installation and modification, poor air quality, and high-pressure losses are all common problems. Now, Simplair solves these problems with its unique 110 mm (4") and 150 mm (6") Evolution System that makes installation fast, simple, and economical.

Thanks to a revolutionary design, Simplair Evolution means big benefits for your business.

- Low operation costs
- Fast installation
- Simple connections
- High flow performance
- Low pressure drop
- Outstanding structural strength
- Lightweight components
- Noncorrosive

Constructed of anodized aluminum extrusion, Evolution is a modular piping system that's ideal for compressed air installations of any size. Yet despite its quick, easy assembly, Evolution offers unexpected flow rates of up to 8,000 cfm for compressor room applications and even higher for most factory loop systems.

With Simplair Evolution, you gain advantages formerly unheard of in integrated piping systems.

#### Advantages

<b>Flexible Design</b>	Evolution's modular design means quick, easy installation. Even system modifications can be completed in seconds, minimizing downtime.
<b>Superior Performance</b>	The smooth bore of Evolution tubing prevents high-pressure losses, and allows higher flow rates than traditional piping systems.
<b>Easy Expansion</b>	Because outlets and connections can be made in seconds, expansion is simple with minimum cost and production disruptions.
<b>High Air Quality</b>	Each Evolution tube is anodized to prevent corrosion from forming inside pipes, affording contaminant-free air throughout the system.
<b>Leak-Free Seals</b>	Our positive "O" ring seal ensures that leaks will not occur at any stage of the system's life.
<b>Lightweight Material</b>	Evolution offers the same structural strength of traditional piping, but with less than a quarter of the weight, making it the perfect choice for roof structures, walls or machinery.
<b>Sleek Appearance</b>	Ergonomically designed to fit the demands of modern production facilities, Evolution can enhance any working environment.

## Compressed Air Piping System



Description	Length	Bore Size		CCN
Simplair-Evolution Pipe	20ft	1.5"	(40mm)	22189229
Simplair-Evolution Pipe	20ft	2"	(50mm)	22194328
Simplair-Evolution Pipe	20ft	2.5"	(63mm)	22194336
Simplair-Evolution Pipe	20ft	3"	(80mm)	22189237
Simplair-Evolution Pipe	20ft	4"	(110mm)	22194344
Simplair-Evolution Pipe	20ft	6"	(150mm)	22194351



Description	Bore Size		CCN
Straight Joint	1.5"	(40mm)	22412662
Straight Joint	2"	(50mm)	22412803
Straight Joint	2.5"	(63mm)	22412902
Straight Joint	3"	(80mm)	22412985
Straight Joint	4"	(110mm)	22342596
Straight Joint	6"	(150mm)	22342604



Description	Bore Size		CCN
Elbow Joint	1.5"	(40mm)	22412688
Elbow Joint	2"	(50mm)	22412829
Elbow Joint	2.5"	(63mm)	22412928
Elbow Joint	3"	(80mm)	22413009
Elbow Joint	4"	(110mm)	22342638
Elbow Joint	6"	(150mm)	22342646



## Compressed Air Piping System



Description	Bore Size	CCN
Tee Joint	1.5" (40mm)	22412670
Tee Joint	2" (50mm)	22412811
Tee Joint	2.5" (63mm)	22412910
Tee Joint	3" (80mm)	22412993
Tee Joint	4" (110mm)	22342612
Tee Joint	6" (150mm)	22342620



Description	Bore Size	CCN
Endcap	1.5" (40mm)	22412654
Endcap	2" (50mm)	22412795
Endcap	2.5" (63mm)	22412894
Endcap	3" (80mm)	22412977
Endcap	4" (110mm)	22342570
Endcap	6" (150mm)	22342588



Description	Bore Size	CCN
<b>40mm</b> Male Thread Adaptor	0.5"	22412753
<b>40mm</b> Male Thread Adaptor	1"	22412779
<b>40mm</b> Male Thread Adaptor	1.5"	22412738
<b>50mm</b> Male Thread Adaptor	1"	22412878
<b>50mm</b> Male Thread Adaptor	2"	22412852
<b>63mm</b> Male Thread Adaptor	2"	22412951
<b>80mm</b> Male Thread Adaptor	2"	22413033
<b>80mm</b> Male Thread Adaptor	3"	22413017

## Compressed Air Piping System



Description	Bore Size NPT	CCN
40mm Outlet Plate	0.5"	22412696
40mm Outlet Plate	1"	22412704
50mm Outlet Plate	0.5"	22412837
50mm Outlet Plate	1"	22412845
63mm Outlet Plate	0.5"	22412837
63mm Outlet Plate	1"	22412845
80mm Outlet Plate	0.5"	22342471
80mm Outlet Plate	1"	22342497
80mm Outlet Plate	2"	22342513
110mm Outlet Plate	0.5"	22342471
110mm Outlet Plate	1"	22342497
110mm Outlet Plate	2"	22342513
150mm Outlet Plate	0.5"	22342471
150mm Outlet Plate	1"	22342497
150mm Outlet Plate	2"	22342513



Description	Bore Size	CCN
ANSI Flange Adaptor	4" (110mm)	22342539
ANSI Flange Adaptor	6" (150mm)	22342554



Description	Bore Size	CCN
4" Step Down Adaptor	110mm-80mm	22487748
6" Step Down Adaptor	150mm-110mm	22487730

## Piping System Accessories and Tools

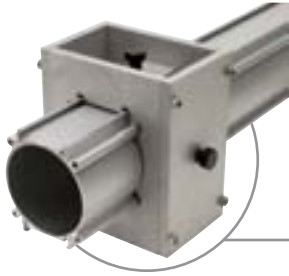

Description	Bore Size	CCN
Cut-Off Fixture	4" (110mm)	22448906
Cut-Off Fixture	6" (150mm)	22404651



Description	CCN
Deburring Tool	88162474
Blades	89238133



Description	Bore Size	CCN
Drill Jig	40mm	22487672
Drill Jig	50, 63mm	22487680
Drill Jig	80, 110, 150mm	22455356

## Piping System Accessories and Tools



Description	Bore Size	CCN
Pilot Drill Bit 1/4"	40, 150mm	22604557



Description	Bore Size	CCN
Tap	40, 50, 63mm	22598593
Tap	80, 110mm	22598601
Tap	150mm	22598619

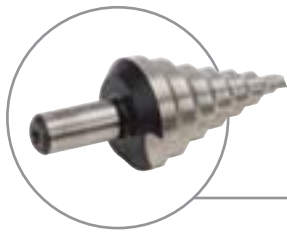

Description	Bore Size	CCN
Step Drill	40, 150mm	88162441



Description	Bore Size	CCN
M6 Tap Socket Adaptor 1/4" Drive *	40, 50, 63mm	22604532
M6 Tap Socket Adaptor 3/8" Drive *	40, 50, 63mm	22604540
M8 Tap Socket 3/8" Drive	80, 110mm	22604516
M12 Tap Socket 3/8" Drive	150mm	22604524

\* Both items needed when using 3/8" drive impact gun

## Piping System Accessories and Tools

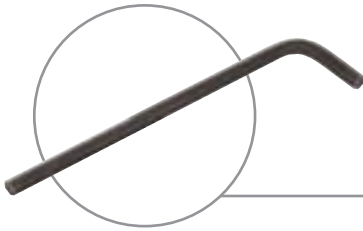

Description	Bore Size	CCN
Allen Key	40, 150mm	22604565

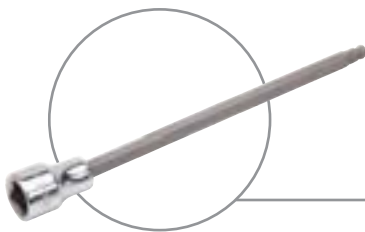

Description	Bore Size	CCN
5mm Ball Nose Allen Key (3/8" Drive)	40, 63mm	22604300
6mm Ball Nose Allen Key (3/8" Drive)	80, 110mm	22604292
10mm Ball Nose Allen Key (3/8" Drive)	150mm	22545040
5mm Ball Nose Allen Key (Hex L Type)	40, 63mm	22605133
6mm Ball Nose Allen Key (Hex L Type)	80, 110mm	22605125
10mm Ball Nose Allen Key (Hex L Type)	150mm	22545073



Description	Bore Size	CCN
Hanging Bracket	1.5" (40mm)	22487698
Hanging Bracket	2" (50mm)	22487706
Hanging Bracket	2.5" (63mm)	22487706
Hanging Bracket	3" (80mm)	22487706
Hanging Bracket	4" (100mm)	22487714
Hanging Bracket	6" (150mm)	22487722

## Piping System Accessories and Tools

Description	Size	CCN
<b>40mm</b> Toggle Hanger (Cable)	5ft	22128508
<b>40mm</b> Toggle Hanger (Cable)	10ft	22128516
<b>40mm</b> Toggle Hanger (Cable)	15ft	38330726
<b>40mm</b> Toggle Hanger (Cable)	30ft	38330734
<b>50mm</b> Toggle Hanger (Cable)	5ft	22128508
<b>50mm</b> Toggle Hanger (Cable)	10ft	22128516
<b>50mm</b> Toggle Hanger (Cable)	15ft	38330726
<b>50mm</b> Toggle Hanger (Cable)	30ft	38330734
<b>63mm</b> Toggle Hanger (Cable)	5ft	22128508
<b>63mm</b> Toggle Hanger (Cable)	10ft	22128516
<b>63mm</b> Toggle Hanger (Cable)	15ft	38330726
<b>63mm</b> Toggle Hanger (Cable)	30ft	38330734
<b>80mm</b> Toggle Hanger (Cable)	5ft	22128508
<b>80mm</b> Toggle Hanger (Cable)	10ft	22128516
<b>80mm</b> Toggle Hanger (Cable)	15ft	38330726
<b>80mm</b> Toggle Hanger (Cable)	30ft	38330734
<b>100mm</b> Toggle Hanger (Cable)	5ft	38330825
<b>100mm</b> Toggle Hanger (Cable)	10ft	38330833
<b>100mm</b> Toggle Hanger (Cable)	15ft	38330841
<b>100mm</b> Toggle Hanger (Cable)	30ft	38330858*
<b>150mm</b> Toggle Hanger (Cable)	5ft	38330825
<b>150mm</b> Toggle Hanger (Cable)	10ft	38330833
<b>150mm</b> Toggle Hanger (Cable)	15ft	38330841
<b>150mm</b> Toggle Hanger (Cable)	30ft	38330858*



No. 2 cable size  
 Packaged 10 lengths per pack  
 \*Packaged 5 lengths per pack

## Flow Rates Through Tubing

### Pressure – Bar (PSIG)

DIAMETER		7 (103)			8 (118)			10 (147)			12 (176)			14 (203)		
mm	in	L/sec	M3/Min	SCFM	L/sec	M3/Min	SCFM	L/sec	M3/Min	SCFM	L/sec	M3/Min	SCFM	L/sec	M3/Min	SCFM
40	1.5	112.8	6.7	239	125	7.52	265	138.7	8.32	294	151	9.05	320	162.8	9.76	345
50	2	212.4	12.74	450	228.9	13.71	485	251	15.04	532	276	16.55	585	292.6	17.55	620
63	2.5	391.7	23.5	830	420	25.19	890	467.7	28.05	991	509.7	30.58	1080	546	32.77	1157
80	3	731	43.86	1549	777.8	46.67	1648	862.7	51.77	1828	951	57.06	2015	1028	61.71	2179
110	4	1675	100	3550	1801	108	3817	2007	120	4254	2178	130	4615	2342	140	4963
150	6	3770	226	7990	4008	240	8493	4490	269	9513	4887	293	10356	5247	315	11119

Flows are based on 1 psig pressure drop per 30 meters (100ft). Tested to OSP 2944.  
Measured at standard atmospheric conditions – 1013 mbar (14.7 psi) at 20°C (68°F).

### Technical Specifications

DESC.	INT. DIA.		EXT. DIA.		STANDARD PIPE LENGTH		WEIGHT		MAX. WORKING PRESSURE		TESTED PRESSURE		MAX. TEMP.		MIN. TEMP.	
	mm	in	mm	in	meters	ft	Kg/Mtr	lbs/ft	bar	psig	bar	psig	C°	F°	C°	F°
Evolution 40	40	1.5	71.07	2.798031496	6	20	1.539	1.03	14	203	**	**	130	266	-30	-22
Evolution 50	50	2	83.48	3.286614173	6	20	1.93651	1.3	14	203	**	**	130	266	-30	-22
Evolution 63	63	2.5	95.19	3.747637795	6	20	2.50508	1.68334	14	203	**	**	130	266	-30	-22
Evolution 80	80	3	122.33	4.816141732	6	20	3.40475	2.28789	13.79	203*	**	**	130	266	-30	-22
Evolution 110	110	4	149.57	5.888582677	6	20	5.36842	3.60741	13.79	203*	**	**	130	266	-30	-22
Evolution 150	150	6	185.4	7.299212598	6	20	7.34875	4.93813	11.72	151	**	**	130	266	-30	-22

\* Outlet plates are rated for 177 psig

\*\* 4 X MAWP with a 0.8 casting factor

Example 1: Casting Proof Test Pressure for 170 psig MAWP is  $170 \times 4/8 = 850$  psig proof test pressure

Example 2: Non-casting Proof Test Pressure for 170 psig MAWP is  $170 \times 4 = 680$  psig proof test pressure

# Flow Rates Through Tubing

## Aluminium Extrusion – Material Specification

Simplair extrusions are manufactured to EAA 6063 series.

### Mechanical Properties

	T6	T6
<b>Temper</b>	T6	T6
<b>Ultimate Tensile Strength</b>	195 N/mm <sup>2</sup>	30 KSI (min)
<b>Proof Stress 0.2%</b>	160 N/mm <sup>2</sup>	25 KSI (min)
<b>(%) Elongation (50mm)</b>	7	7
<b>Modules of Elasticity</b>	69x10 <sup>3</sup> mPa	10.0x10 <sup>3</sup> KSI

### Physical Properties

<b>Density</b>	2.70x10 <sup>-6</sup> kg/mm <sup>3</sup>	0.0975 lb/in <sup>3</sup>
<b>Melting Range</b>	615-655°C	1140-1210°F
<b>Specific Heat</b> <small>between 0°-100°C</small>	879 J/kgK	22x10 <sup>4</sup> BTU/lb°F
<b>Coefficient of Linear Expansion</b> <small>between 20°-100°C</small>	23x10 <sup>-6</sup> /K	13.0x10 <sup>-6</sup> /°F
<b>Electrical Resistivity at 20°C</b>	0.033uΩm	0.033uΩm

### Nominal Chemical Properties % of Weight

Copper	0.10 max.
Iron	0.35 max.
Magnesium	0.46
Manganese	0.10 max.
Silicon	0.40
Titanium	0.10 max.
Zinc	0.15 max.
Chromium	0.10 max.
Others, each	0.05 max.
Others, total	0.15 max.
Aluminum	Remainder

Aluminium is a corrosion-resistant metal due to a film of aluminium oxide that occurs naturally on its surface. Anodizing is an applied finish by an electrochemical process. It thickens the natural oxide film on the aluminium and imparts to the metal surface the extreme hardness, corrosion and wear resistance of the oxide. Simplair is anodized to AA10 which signifies a 10 micron depth of anodizing.

All HBS Products meet the requirements of ANSI B31.1, BS1387, BS8118, TÜV

## Piping and Distribution Accessories



### Low Pressure – Ultra Duty Hose Reel including Hose

Our ultra duty Hose Reels are manufactured of all steel construction with a durable powder coat finish.

### Low Pressure – Heavy Duty Hose Reel including Hose

Our new composite hose reel (depicted to the left) provides excellent durability at a great value. All composite reels are made of tough glass-filled composite material combined with a strong base.

CCN	PERFORMANCE RATING	MAX. PRESSURE psig	HOSE LENGTH ft	HOSE ID	DIMENSIONS			SPOOL MATERIAL
					L	W	H	
80105471	Ultra Duty	300	50	0.375"	16.5"	6"	17.5"	Steel
80105521	Ultra Duty	300	50	0.5"	16.5"	6"	17.5"	Steel
80105489	Heavy Duty	300	50	0.375"	17.75"	7"	20.37"	Composite
80105513	Heavy Duty	300	50	0.5"	17.75"	7"	20.37"	Composite



### Air Hose – Simclair Speed-Lok

Ingersoll-Rand Speed-Lok hose is a general-purpose hose made of a high-quality, durable synthetic rubber. The hose is ideal for general industrial, maintenance and automotive applications. The hose has a blue shell, color-coded for "compressed air." The maximum temperature limit for the hose is 158°F. The working pressure is 250 PSIG and the burst pressure is 1,000 PSIG.

ROLL	CCN PER FOOT	DESCRIPTION	HOSE ID	HOSE OD	WEIGHT lbs/ft	MIN. BEND RADIUS
38032249	38032223	3/8" Hose	0.38"	0.63"	0.11	3
38032926	38032231	1/2" Hose	0.5"	0.78"	0.18	5

## Piping and Distribution Accessories

### Hoses – Quick Connect Fittings

The Ingersoll-Rand quick couplings have hardened wear points and load bearing areas (for steel nipples only) and precision-machined surfaces for durability in the toughest applications. Precision-molded seals form a tight seal for reliable operation, and hardened steel locking balls provide a strong connection with evenly distributed loads. The 3/8-inch body size couplers have larger orifices to minimize pressure drop. For a complete set, both a coupler and nipple of the same body size are required.

#### Technical Specifications

<b>Body Size</b>	1/4, 40 cfm	3/8, 90 cfm
<b>Related Pressure PSI</b>	300	300
<b>Temperature Range</b>	-40°F to +250°F	-40°F to +250°F
<b>Locking Device</b>	4 balls	6 balls
<b>Vacuum Data, in Hg:</b>	—	—
<b>Disconnected (coupler only):</b>	Not Recommended	Not Recommended
<b>Connected:</b>	27.4	28.2

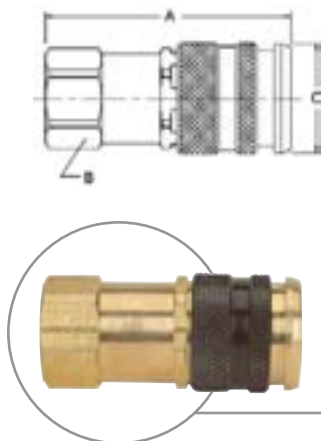

#### Female Pipe Thread

CCN	Material	Body Size	Thread Size
38328464	Brass	0.375"	1/4-18
38328472	Brass	0.375"	3/8-18
38328480	Brass	0.375"	1/2-14
38328597	Brass	0.25"	1/4-18
38328605	Brass	0.25"	3/8-18

## Piping and Distribution Accessories

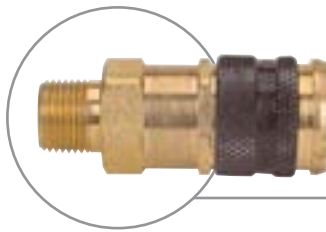
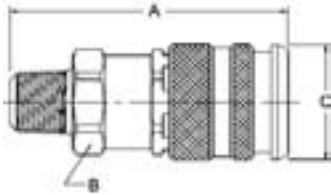

### Male Pipe Thread Coupler

CCN	Material	Body Size	Thread Size
38328431	Brass	0.375"	1/4-18
38328449	Brass	0.375"	3/8-18
38328456	Brass	0.375"	1/2-14
38328563	Brass	0.25"	1/4-18
38328571	Brass	0.25"	3/8-18

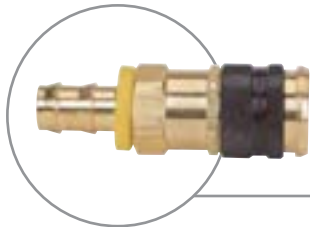
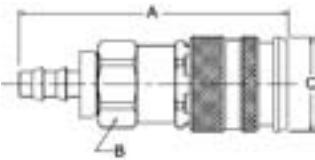

### Speed-Lok Hose Barb Coupler

CCN	Material	Body Size	Hose ID
38328498	Brass	0.375"	3/8
38328506	Brass	0.375"	1/2
38328613	Brass	0.25"	3/8

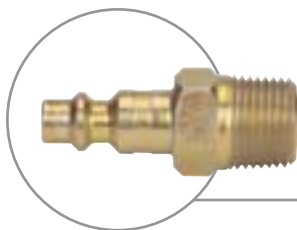
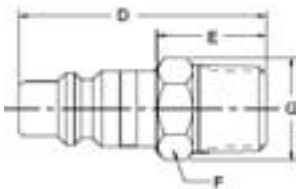

### Male Pipe Nipple

CCN	Material	Body Size	Thread Size
38328514	Steel	0.375"	1/4-18
38328522	Steel	0.375"	3/8-18
38328530	Steel	0.375"	1/2-14
38328639	Steel	0.25"	1/4-18
38328647	Steel	0.25"	3/8-18

## Piping and Distribution Accessories

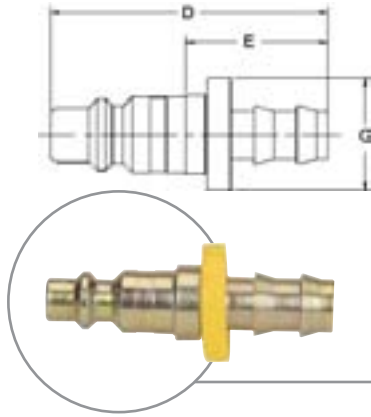

### Speed-Lok Hose Barb Nipple

CCN	Material	Body Size	Hose ID
38328548	Steel	0.375"	3/8
38328555	Steel	0.375"	1/2
38328662	Steel	0.25"	3/8

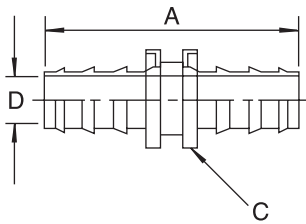

### Push-on Hose Barb Union

CCN	Hose Size
38034252	3/8"
38034260	1/2"

### Point-of-Use Provider Manifold

The outlet manifold provides a simple, cost-effective solution to the untidy array of tees and elbows normally used to create outlets. The manifold is made of lightweight, durable anodized aluminum and features the following outlets: (2) 1-inch NPT (top and bottom), (2) 1/2" NPT, (2) 3/8" NPT and (2) 1/4" NPT. Plugs are provided for each outlet and have O-rings so that pipe sealant is not required.



CCN	Model
38004339	Point-of-Use Provider Manifold



## Ball Valves

### Ball Valves

Ingersoll-Rand forged body ball valves provide extended service life and resist failure caused by severe temperature applications. Full-flow design ensures maximum system efficiency. Highly inert PTFE seats provide resistance to chemical corrosion. Two Viton O-rings at the stem provide maximum safety with no maintenance. The blow-out proof stem, chrome-plated brass ball and specifically designed handle enable increased turning leverage for ease of opening and closing. Ingersoll-Rand ball valves can be readily identified, ensuring high-quality engineering and reliability. These economical ball valves are available in female pipe sizes.

Size NPT	CCN
0.5"	54634431
0.75"	54634449
1.0"	54634456
1.25"	54634464
1.5"	54634472
2.0"	54634480
2.5"	54634498
3.0"	54634514

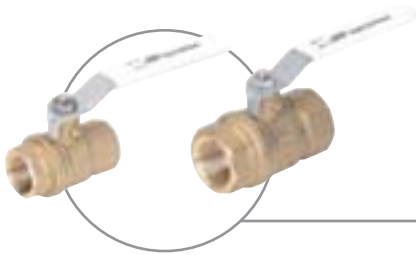

Please be aware that ball valves are intended for use in the fully open or closed positions. Depending on application conditions, throttling of the valve may result in premature seal failure and/or inability to turn the valve handle.

## System Pressure Controllers



### Intelliflow – PID Controlled

- Control +/- 0.75 psi within flow range
- Seamless 2" - 6"
- Butterfly valve controlled
- Standard and high performance models

CCN	Model	Performance Level	Min. Flow (SCFM) @ 125 PSI(G)'	Max. Flow
42548719	IR-BP-BV 2.0	Standard	170	850
42548727	IR-BP-BV 3.0	Standard	307	1571
42548743	IR-BP-BV 4.0	Standard	495	3033
42548768	IR-BP-BV 6.0	Standard	1023	7855
42550970	IR-BP-BV 8.0	Standard	2100	15900
42548735	IR-BP-BV 3.0-HP	High (Triple Offset)	175	1620
42548750	IR-BP-BV 4.0-HP	High (Triple Offset)	333	3127
42548776	IR-BP-BV 6.0-HP	High (Triple Offset)	807	8098
42544304	IR-BP-BV 8.0-HP	High (Triple Offset)	1827	17085



### PacE .5, I & II Air System Pressure Controllers

PacE air controllers provide total air system control through a single device, giving you the ability to see both upstream and downstream pressures from one convenient location.

### Technical Specifications

	PacE .5	PacE I	PacE II
CCN	38342119	38334314	38041166
Connection Size (female)	0.5" NPT	1" NPT	2" NPT
Maximum Flow	40 scfm	250 scfm	650 scfm
Maximum Inlet Pressure	232 psig	232 psig	150 psig
Control Range	144 psig-7 psig	144 psig-7 psig	150 psig-7 psig
Max Operating Temperature	176°F (80°C)-4°F (-20°C)	176°F (80°C)-4°F (-20°C)	176°F (80°C)-4°F (-20°C)
Sensitivity	0.2% of full span	0.2% of full span	0.2% of full span
Repeatability	±0.5% of full span	±0.5% of full span	±0.5% of full span

# More Than Air. Solutions.

Online solutions: [www.air.irco.com](http://www.air.irco.com)

Ingersoll-Rand compressors are not designed, intended or approved for breathing air applications. Ingersoll-Rand does not approve specialized equipment for breathing air applications and assumes no responsibility or liability for compressors used for breathing air service.

Nothing contained on these pages is intended to extend any warranty or representation, expressed or implied, regarding the product described herein. Any such warranties or other terms and conditions of sale of products shall be in accordance with Ingersoll-Rand's standard terms and conditions for such products, which are available upon request.

Product improvement is a continuing goal at Ingersoll-Rand. Designs and specifications are subject to change without notice or obligation.



#### **Ingersoll-Rand Company**

Air Solutions  
P.O. Box 1803  
800-B Beaty Street  
Davidson, NC 28036  
1-800-526-3615 or 1-800-247-2667

#### **Ingersoll-Rand SEA (pte), Limited**

Jurong Town  
P.O. Box 88  
Singapore 916103  
(65) 68611555

#### **Ingersoll-Rand European Sales Limited**

Swan Lane, Hindley Green  
Wigan WN2 4EZ United Kingdom  
+44 (0) 1942 257171

[www.air.irco.com](http://www.air.irco.com)